

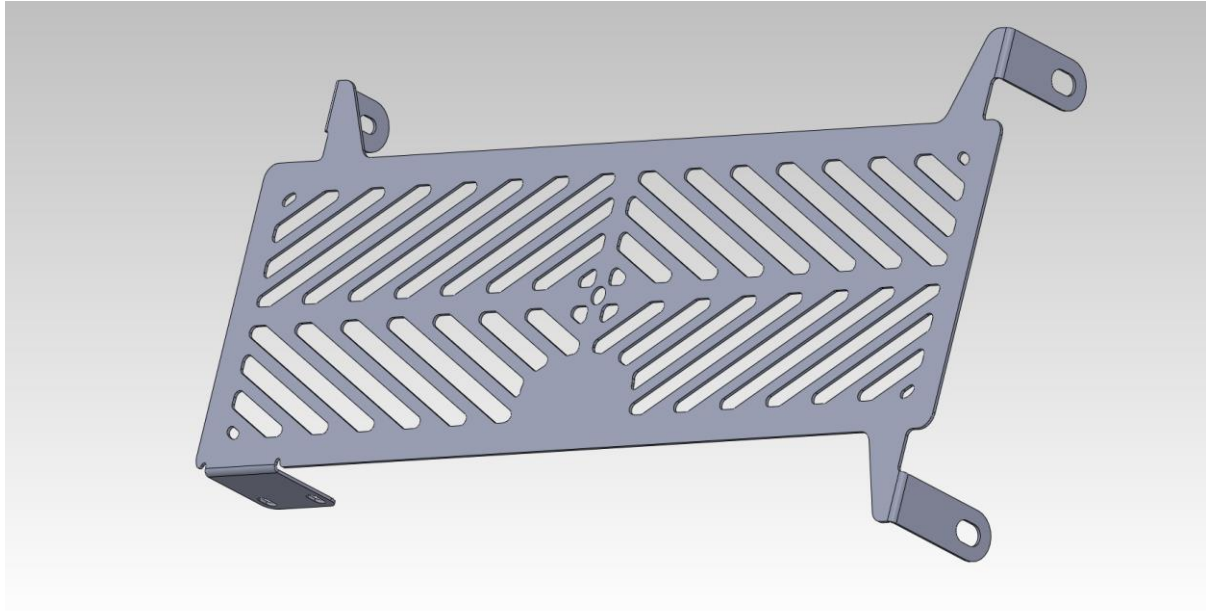

Fitting Instructions for SRG0038 Radiator Guard
HONDA VFR800F '14- & VFR800X CROSRUNNER '15-

Page | 1



In This Kit There Should Be
1x Radiator Guard (SS RAD0038).
2x 100mm Lengths of self-adhesive Foam.
4 x 4mm x 220mm long cable-ties.

TOOLS REQUIRED

- Socket set to include 8 and 10mm spanners or sockets & wrenches.
 - 4 and 5mm Allen key.

If fitting to the VFR800F '14-

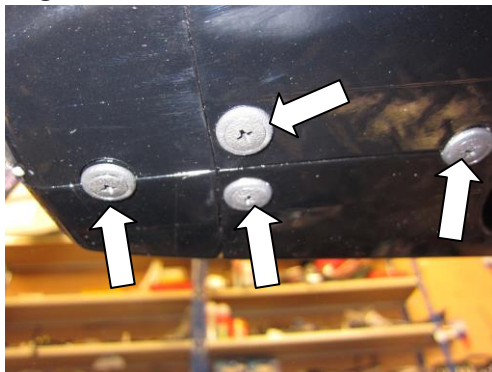

PICTURE 1

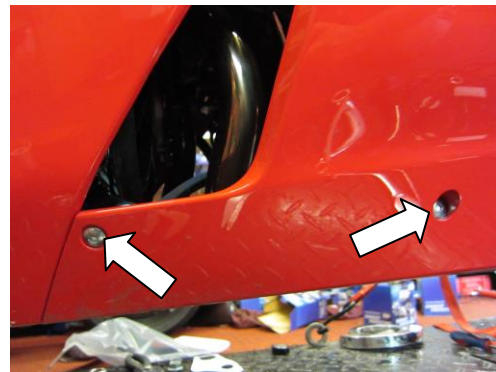

PICTURE 2

R&G Racing

Unit 1 Shelleys Lane, East Worldham, Alton, Hants GU34 3AQ
 Tel: +44 (0)1420 89007 Fax: +44 (0)1420 87301 www.rg-racing.com Email: info@rg-racing.com

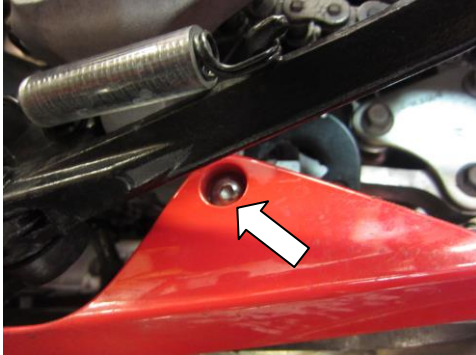

PICTURE 3

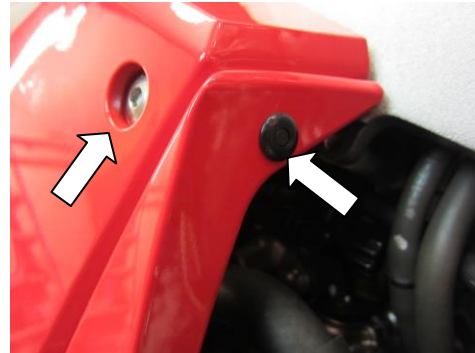

PICTURE 4



PICTURE 5

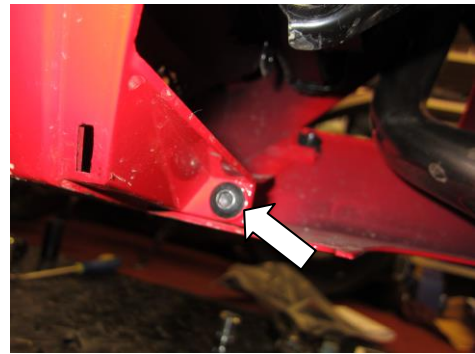

PICTURE 6



PICTURE 7

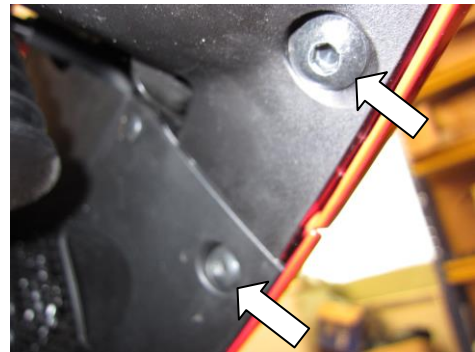

PICTURE 8

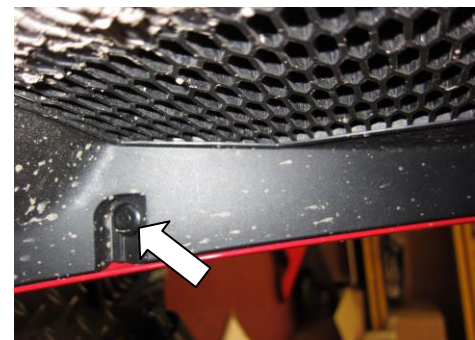

R&G Racing

Unit 1 Shelleys Lane, East Worldham, Alton, Hants GU34 3AQ

Tel: +44 (0)1420 89007 Fax: +44 (0)1420 87301 www.rg-racing.com Email: info@rg-racing.com

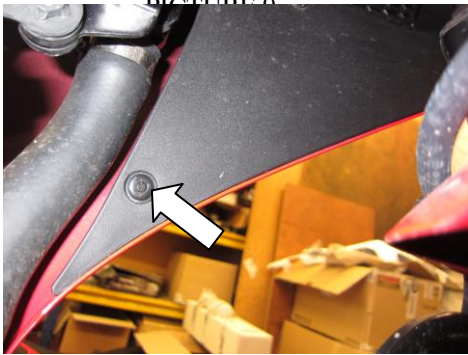

PICTURE 11

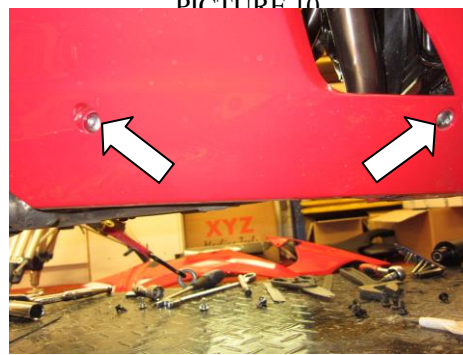

PICTURE 12

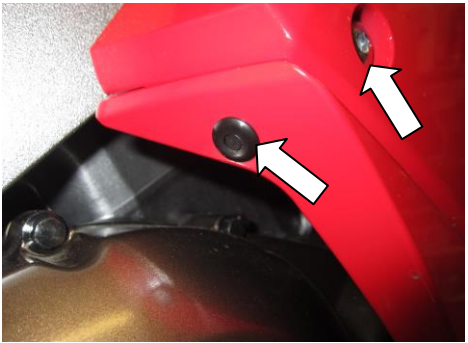

PICTURE 13

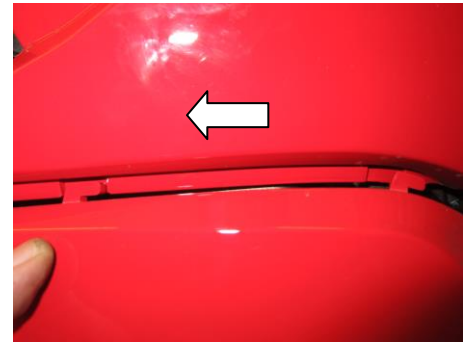

PICTURE 14



PICTURE 15

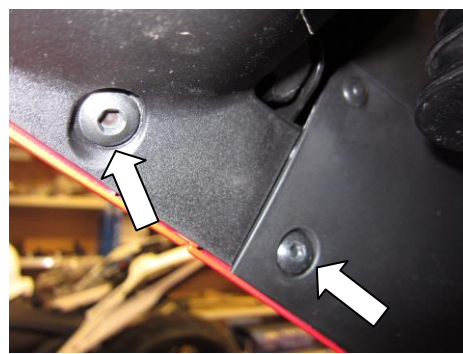

PICTURE 16



PICTURE 17



PICTURE 18

R&G Racing

Unit 1 Shelleys Lane, East Worldham, Alton, Hants GU34 3AQ

Tel: +44 (0)1420 89007 Fax: +44 (0)1420 87301 www.rg-racing.com Email: info@rg-racing.com

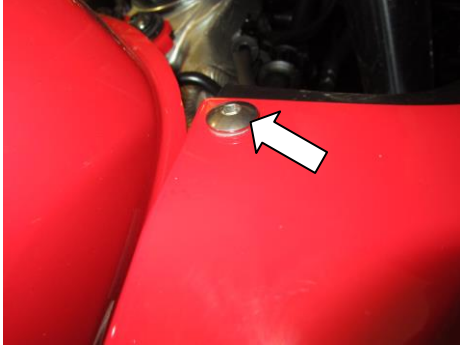

PICTURE 19

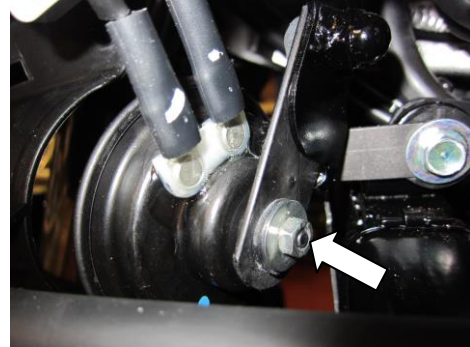

PICTURE 20

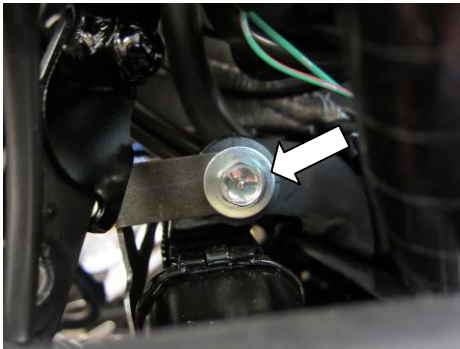

PICTURE 21



PICTURE 22

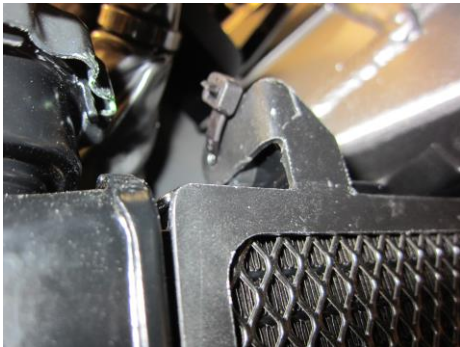

PICTURE 23



PICTURE 24

FITTING INSTRUCTIONS

Near side (left side as you sit on bike)

- Remove the four plastic rivets arrowed in picture 1.
- Remove the four fairing bolts and the plastic push rivet arrowed in pictures 2, 3 and 4.
- Gently remove the left hand side lower fairing (please note the direction of removal as shown in picture 5).
- Remove the bolt arrowed in picture 6.
- Remove the bolts and push rivet arrowed in pictures 7, 8, 9, 10 and 11 and gently remove the upper fairing.

R&G Racing

Unit 1 Shelleys Lane, East Worldham, Alton, Hants GU34 3AQ

Tel: +44 (0)1420 89007 Fax: +44 (0)1420 87301 www.rg-racing.com Email: info@rg-racing.com



Off side (right side as you sit on bike)

- Remove the three fairing bolts and the plastic push rivet arrowed in pictures 12 and 13.
- Gently remove the right hand side lower fairing (please note the direction of removal as shown in picture 14).
- Remove the bolts and push rivet arrowed in pictures 15, 16, 17, 18 and 19 and gently remove the upper fairing.

Near side (left side as you sit on bike)

- To fit the radiator guard to the bike cut the foam strip provided into 10mm wide pieces and stick them to the back of the radiator guard frame, so that they sit between the radiator guard and the radiator.
- Undo and remove the horn mounting nut arrowed in picture 20 and remove the horn (you do not need to disconnect it, just move it so the radiator guard can be offered into position).
- Undo and remove the two bolts arrowed in pictures 21 and 22.
- Offer the radiator guard into position as shown in the top picture and using the original bolts secure in position on the left hand side.
- Refit the horn and check operation.

Off side (right side as you sit on bike)

- Use two of the cable ties supplied and secure the guard in position as shown in pictures 23 and 24.
- Refit the upper and lower fairings.

Near side (left side as you sit on bike)

- Refit the upper and lower fairings.

Digital copies of these instructions are available to download from www.rg-racing.com

If fitting to the VFR800X CROSSRUNNER '15-



Picture A

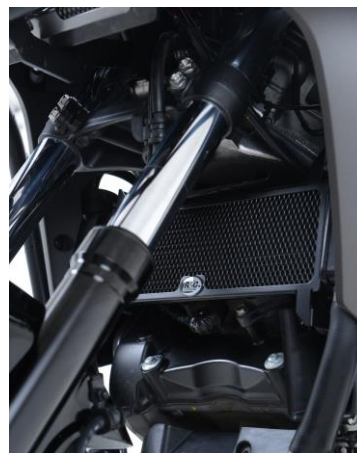

Picture B

R&G Racing

Unit 1 Shelleys Lane, East Worldham, Alton, Hants GU34 3AQ

Tel: +44 (0)1420 89007 Fax: +44 (0)1420 87301 www.rg-racing.com Email: info@rg-racing.com

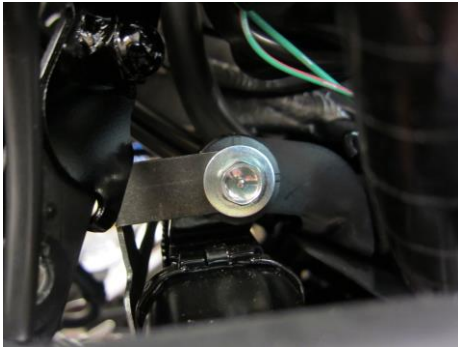

Picture C

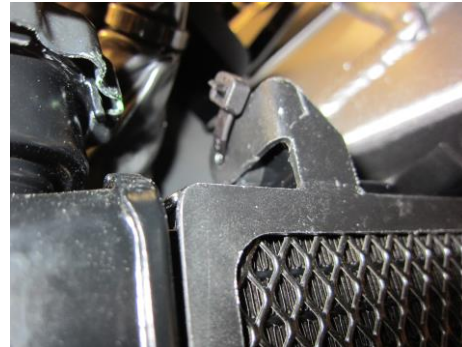

Picture D



Picture E

FITTING INSTRUCTIONS

- Remove the two bolts that secure the left side of the radiator in place, as arrowed in picture A.
- To fit the radiator guard to the bike cut the foam strip provided into 10mm wide pieces and stick them to the back of the radiator guard frame, so that they sit between the radiator guard and the radiator.
- Offer the R&G Radiator Guard into place ensuring the mounting holes align with the radiator mounts, before re-fitting the two original bolts, as shown in pictures B & C.
- Use two of the cable ties supplied and secure the guard in position as shown in pictures D and E.

GENERAL TORQUE SETTINGS

M4 BOLT = 8Nm
 M5 BOLT = 12Nm
 M6 BOLT = 15Nm
 M8 BOLT = 20Nm
 M10 BOLT = 40Nm

ISSUE 2 28/05/2015 (AR)

CONSUMER NOTICE

The catalogue description and any exhibition of samples are only broad indications of the Products and R&G may make design changes which do not diminish their performance or visual appeal and supplying them in such state shall conform to the order. The Buyer acknowledges no representation or warranty (other than as to title) has been given or will apply to the Products other than those in R&G's order or confirmation and the Buyer confirms it has chosen the Products as being of merchantable quality and suitable for its particular purposes. Where R&G fits the Products or undertakes other services it shall exercise reasonable skill and care and rectify any fault free of charge unless the workmanship has been disturbed. The Buyer is responsible for ensuring that the warranty on the motorcycle is not affected by the fitting of the Products. On return of any defective Products R&G shall at its option either supply a replacement or refund the purchase money but shall not be liable if the Products have been modified or used or maintained otherwise than in accordance with R&G's or manufacturer's instructions and good engineering practice or if the defect arises from accident or neglect. Other than identified above and

R&G Racing

Unit 1 Shelleys Lane, East Worldham, Alton, Hants GU34 3AQ

Tel: +44 (0)1420 89007 Fax: +44 (0)1420 87301 www.rg-racing.com Email: info@rg-racing.com



subject to R&G not limiting its liability for causing death and personal injury, it shall not be liable for indirect or consequential loss and otherwise its liability shall be limited to the amounts paid by the Buyer for the Products or the fitting or service concerned. These terms do not affect the Buyer's statutory rights.

R&G RACING RETURNS POLICY (NON-FAULTY GOODS)

Returns must be pre-authorized (if not pre-authorized the return will be rejected). Goods may only be returned direct to us if they were purchased direct from us (customer must prove if necessary). Otherwise to be returned to original vendor. Goods must be in re-sellable condition, in the opinion of R&G Racing. All returns are subject to a 25% restocking and handling fee (25% of the gross value exc. P&P – at the prevailing price at time of purchase). The customer must pay any and all carriage charges. No returns of discontinued products, unless within 14 days of purchase. This policy does not affect your statutory rights and does not refer to faulty goods.

R&G Racing

Unit 1 Shelleys Lane, East Worldham, Alton, Hants GU34 3AQ

Tel: +44 (0)1420 89007 Fax: +44 (0)1420 87301 www.rg-racing.com Email: info@rg-racing.com



Instructions de montage SRG0038 Grille de protection radiateur
HONDA VFR800F '14- & VFR800X CROSRUNNER '15-

Page | 8

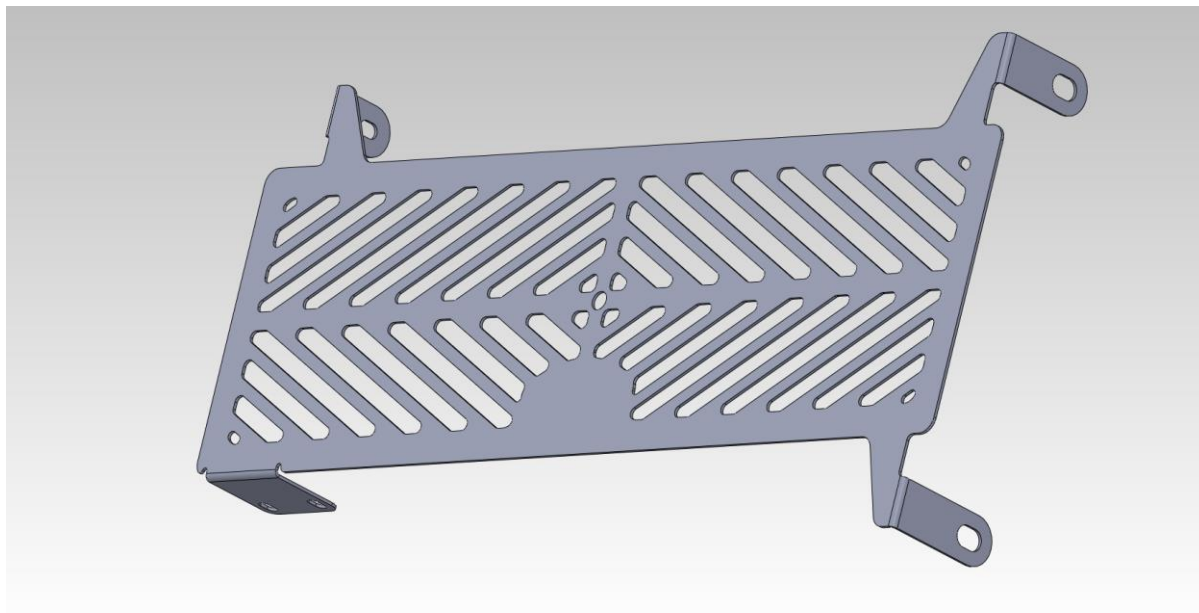

Le kit doit contenir :

- 1x Grille de protection radiateur (SS RAD0038).**
- 2x 100mm Longueurs de mousse autocollante.**
- 4 x 4mm x 220mm colliers de serrage.**

OUTILS REQUIS

- Jeu de clés 8 et 10mm.
- Clé Allen 4 et 5mm.

Si l'installation s'effectue sur VFR800F '14-

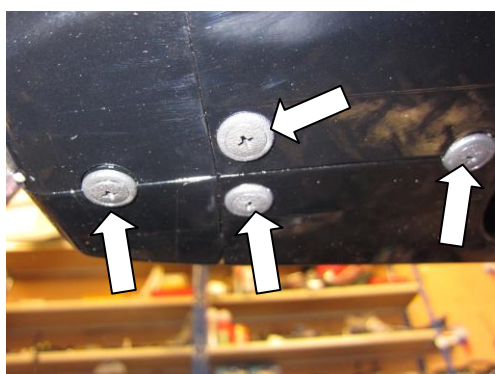

PHOTO 1

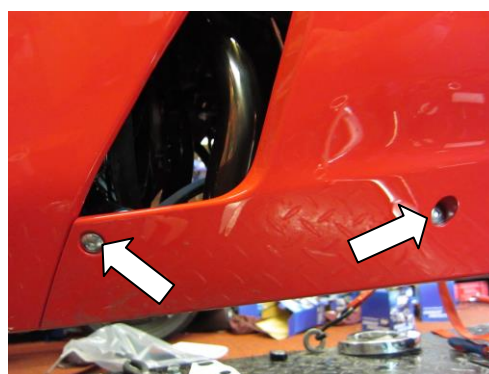

PHOTO 2

R&G Racing

Unit 1 Shelleys Lane, East Worldham, Alton, Hants GU34 3AQ
 Tel: +44 (0)1420 89007 Fax: +44 (0)1420 87301 www.rg-racing.com Email: info@rg-racing.com

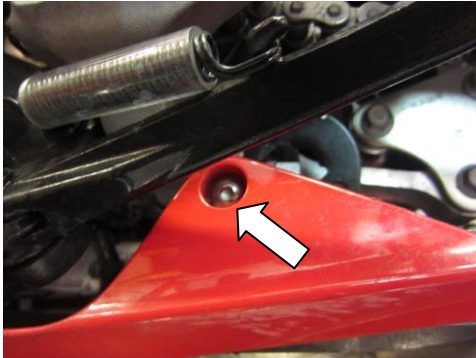

PHOTO 3

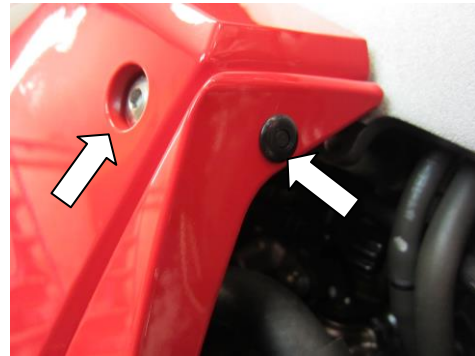

PHOTO 4

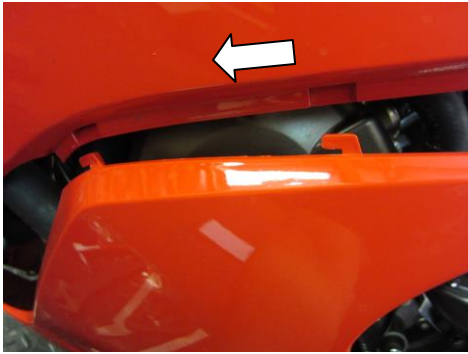

PHOTO 5

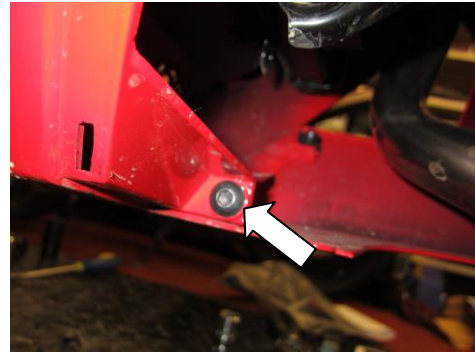

PHOTO 6

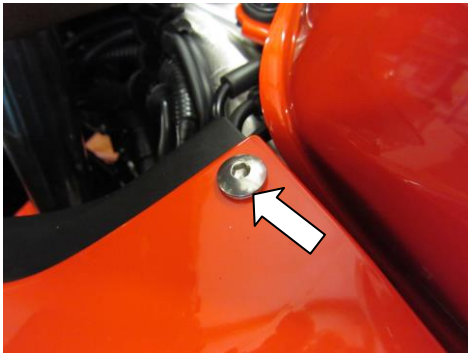

PHOTO 7

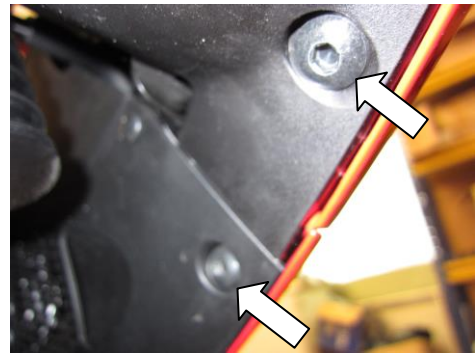

PHOTO 8



PHOTO 9

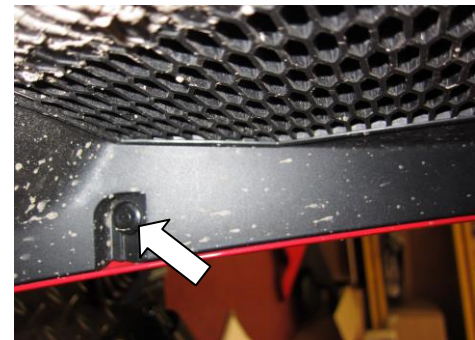

PHOTO 10

R&G Racing

Unit 1 Shelleys Lane, East Worldham, Alton, Hants GU34 3AQ

Tel: +44 (0)1420 89007 Fax: +44 (0)1420 87301 www.rg-racing.com Email: info@rg-racing.com



PHOTO 11

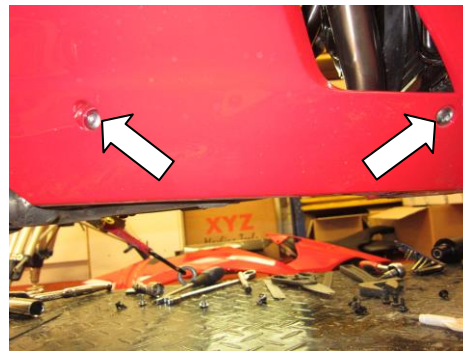

PHOTO 12



PHOTO 13

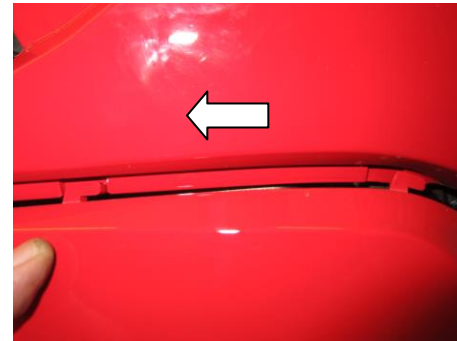

PHOTO 14



PHOTO 15

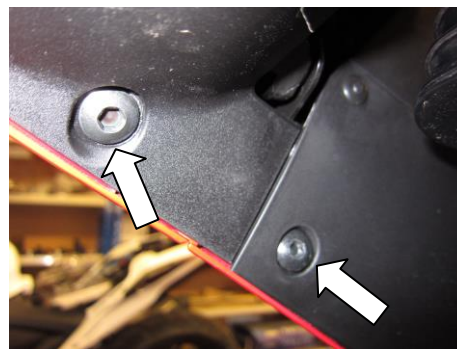

PHOTO 16



PHOTO 17



PHOTO 18

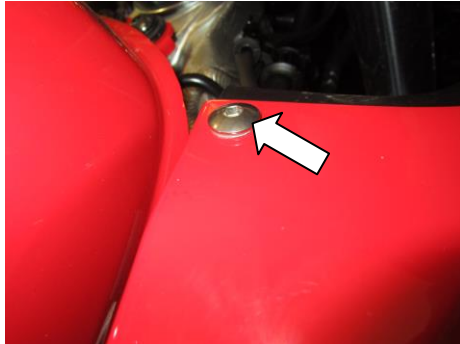

PHOTO 19

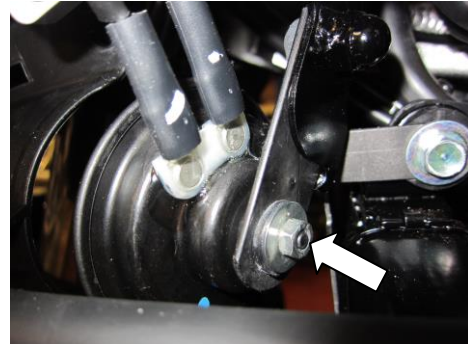

PHOTO 20

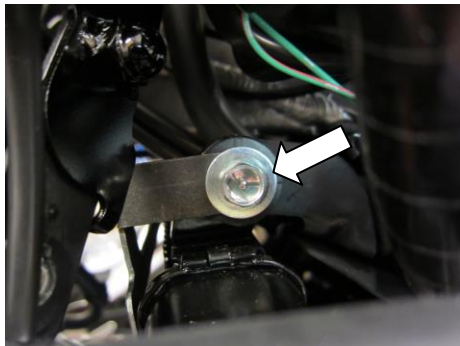

PHOTO 21



PHOTO 22



PHOTO 23



PHOTO 24

INSTRUCTIONS DE MONTAGE

Coté gauche (assis sur la moto)

- Enlever les 4 rivets (photo 1).
- Enlever les 4 boulons et le rivet plastic indiqués sur les photos 2, 3 et 4.
- Enlever doucement le carénage inférieur coté gauche (notez la façon de l'enlever comme sur la photo 5).
- Enlever le boulon indiqué sur la photo 6.
- Enlever les boulons et le rivet indiqué sur les photos 7, 8, 9, 10 et 11 puis enlever doucement le carénage supérieur.

R&G Racing

Unit 1 Shelleys Lane, East Worldham, Alton, Hants GU34 3AQ

Tel: +44 (0)1420 89007 Fax: +44 (0)1420 87301 www.rg-racing.com Email: info@rg-racing.com



Coté droit (assis sur la moto)

- Enlever les 3 boulons de carénage et le rivet indiqué sur les photos 12 et 13.
- Enlever le carénage inférieur droit (notez la façon de l'enlever, comme sur la photo 14).
- Enlever les boulons et le rivet comme sur les photos 15, 16, 17, 18 et 19 puis le carénage supérieur.

Coté gauche (assis sur la moto)

- Pour monter la grille de protection radiateur sur la moto, couper la mousse fournie en bandeaux de 10mm de large et collez les au bas du cadre de grille de protection radiateur, de façon à ce qu'ils se placent entre la grille de protection radiateur et le radiateur.
- Enlever l'écrou de fixation comme sur la photo 20 puis la corne (Vous n'avez pas besoin de la déconnecter, bougez le juste de façon à ce que la grille de protection radiateur puisse être placée correctement).
- Enlever the two bolts arrowed in photos 21 and 22.
- Mettre le grille en position comme sur la photo du haut et utiliser les boulons d'origine pour fixer la position du coté gauche.
- Remettre la corne et vérifier le fonctionnement de l'éclairage..

Coté droit (assis sur la moto)

- Utiliser 2 des colliers de serrage fournis puis fixer la grille de protection en position comme sur les photos 23 et 24.
- Remettre les carénages supérieurs et inférieurs.

Coté gauche (assis sur la moto)

- Remettre les carénages supérieurs et inférieurs.

Ces instructions de montage sont disponibles au téléchargement sur www.rg-racing.com

Si l'installation s'effectue sur VFR800X CROSSRUNNER '15-



Photo A



Photo B

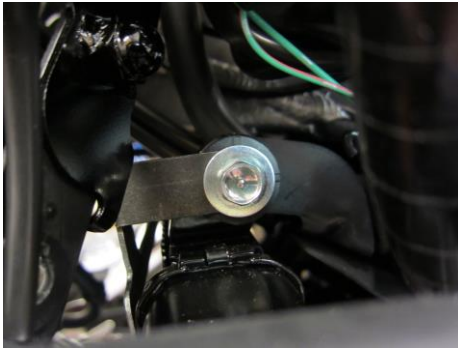

Photo C

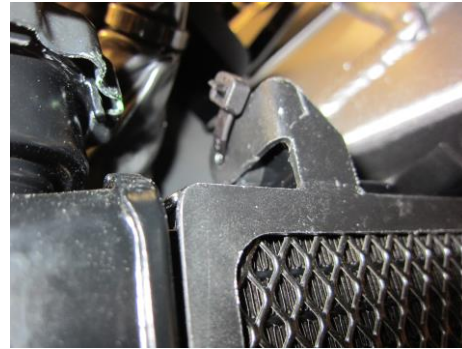

Photo D



Photo E

INSTRUCTIONS DE MONTAGE

- Enlever les 2 boulons qui fixent le radiateur coté gauche en place, voir photo A.
- Pour monter la protection radiateur sur la moto, couper la mousse autocollante fournie en bandeaux de 10mm, puis collez-les au bas du cadre support de protection, de façon à ce qu'ils se placent entre la protection radiateur et le radiateur.
- Mettre la protection en place en veillant à ce que les trous de fixation s'alignent avec les supports radiateur, avant de remettre les 2 boulons d'origine, voir photos B & C.
- Utilisez 2 des colliers fournis pour fixer la protection en place, voir photos D et E.

COUPLES DE SERRAGE RECOMMANDÉS

M4 BOULON = 8Nm
 M5 BOULON = 12Nm
 M6 BOULON = 15Nm
 M8 BOULON = 20Nm
 M10 BOULON = 40Nm

ISSUE 1 28/05/2015 (AR)