



FITTING INSTRUCTIONS FOR ECC0397PRO
LHS ALTERNATOR CASE COVER



THIS KIT CONTAINS THE ITEMS PICTURED AND LABELLED OVER PAGE.
SOME PARTS MAY BE SHOWN FOR CLARITY OF INSTRUCTIONS ONLY.

DO NOT PROCEED UNTIL YOU ARE SURE ALL PARTS ARE PRESENT.

PLEASE READ ALL INSTRUCTIONS BEFORE PROCEEDING.

**IF IN ANY DOUBT WHEN FITTING OUR PRODUCTS, CONSULT ONE OF OUR DEALERS
OR HAVE FITTED BY A QUALIFIED TECHNICIAN.**

**PLEASE BE AWARE THAT THE PLASTIC SKIDDER IS ASSEMBLED IN POSITION FOR PACKAGING
PURPOSES ONLY. YOU WILL NEED TO REMOVE IT, PLACE 1 DROP OF BLUE THREAD LOCK TO
EACH BOLT AND REASSEMBLE ONTO THE ALUMINIUM ENGINE CASE COVER. DO NOT EXCEED
15NM OF TORQUE.**



<u>TOOLS REQUIRED</u>	<u>GENERAL TORQUE SETTINGS</u>
<ul style="list-style-type: none"> • Set of Metric Allen keys. • Metric Socket set. • Suitable Torque Wrench. 	<p>M6 BOLT = 15Nm</p> <p>M8 BOLT = 20Nm</p> <p>M10 BOLT = 40Nm</p> <p>M12 BOLT = 40Nm</p>

LEGEND

ITEM NO.	DESCRIPTION	QTY
ITEM 1	R&G ALUMINIUM ENGINE CASE COVER	1
ITEM 2	SKIDDER ASSEMBLY	1
ITEM 3	M6x55mm CAP HEAD BOLT	4
ITEM 4	12mm OD WASHER	4
ITEM 5	M5x10mm COUNTERSUNK BOLTS	4

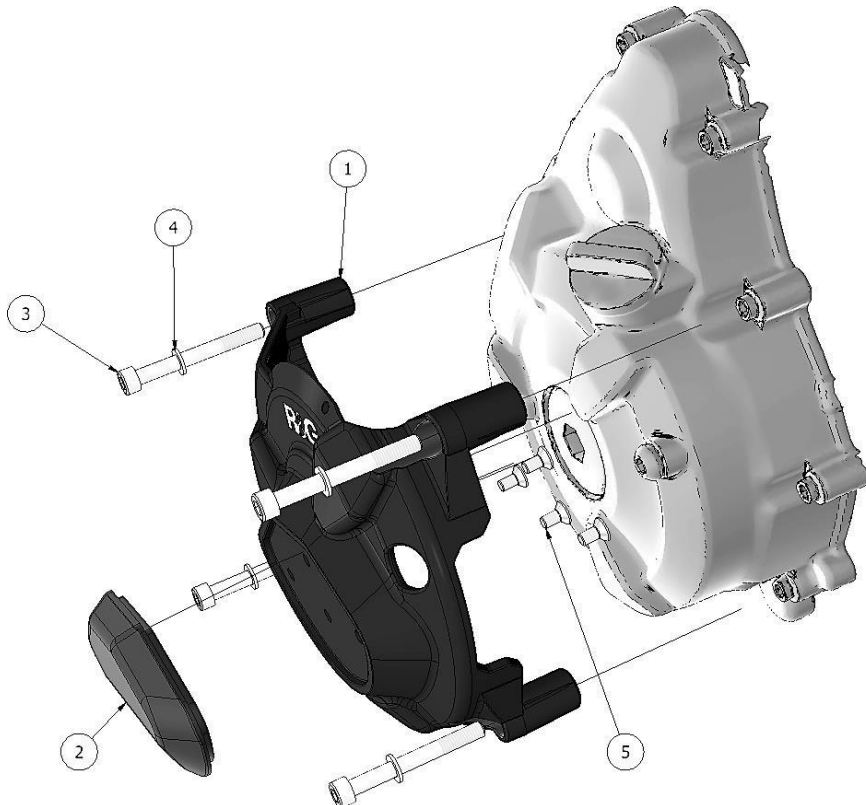



Picture 1

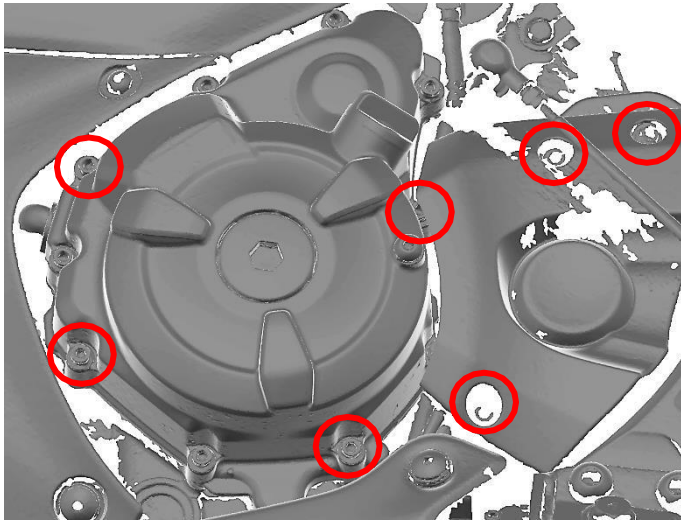

Picture 2

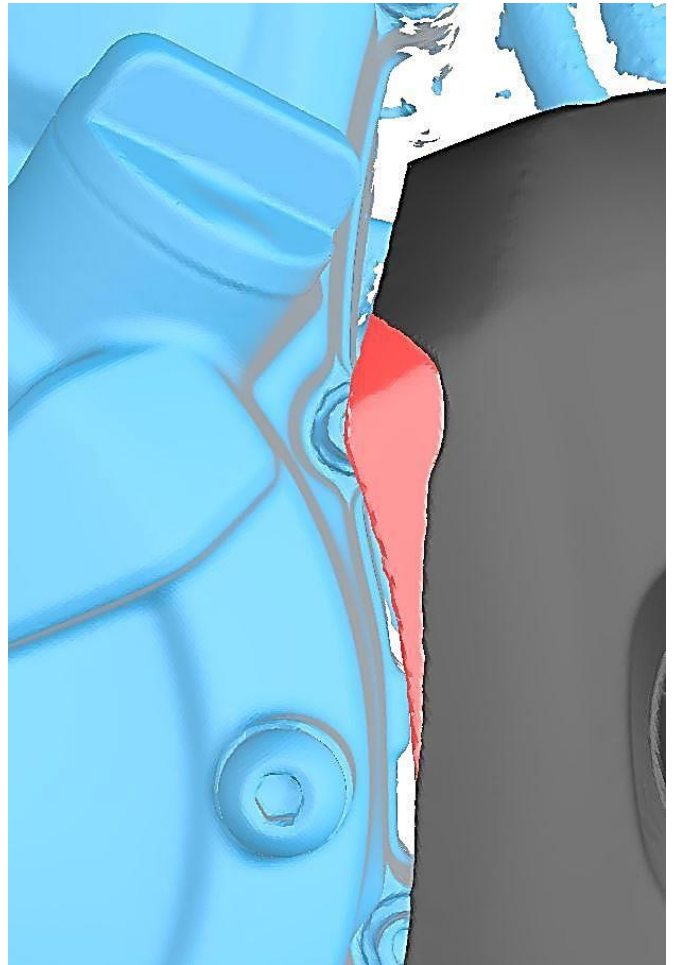



Picture 3



Picture 4

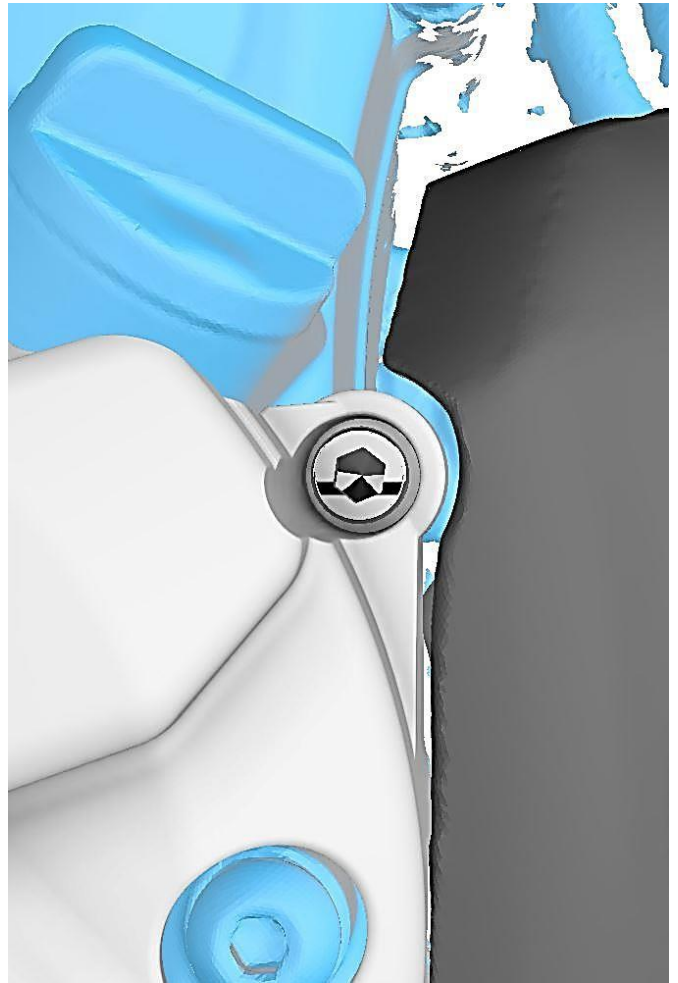

Picture 5

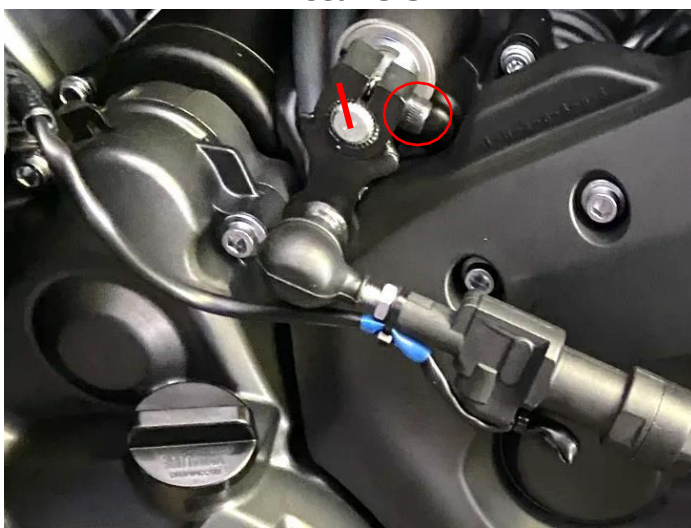



FITTING INSTRUCTIONS

- Ensure the skidder (**ITEM 2**) is fitted securely to the Engine Case Cover (**ITEM 1**) using the 4 x countersunk bolts (**ITEM 5**).
- Please make sure the engine is cold before proceeding with the fitting of the R&G cover.
- Remove the fairings, front sprocket cover and OEM engine case bolts as highlighted in **PICTURE 1. DO NOT REMOVE ALL OF THE CASE BOLTS.**

Please note: *The gear linkage will have to be detached to remove the front sprocket cover via the shaft seen in **Picture 5** by removing the pinch bolt circled in red. If there is no existing alignment marks on the splines, draw on your own alignment mark so that you can refit the linkage in the same position on the splines that it was removed from.*

If not refitted in the same position as it was removed from, the gear lever will sit in a higher or lower position than it was in originally.

- Following the guide on **Picture 3**, Using the 4 x cap head bolts (**ITEM 3**) and washers (**ITEM 4**) provided to secure the engine case cover to the bike.
- With a 5mm hex tool, tighten the bolts equally so that they pull the cover into place. DO NOT FULLY TIGHTEN.
- Finally use a torque wrench set at 10 N/m (7 Lb/ft) to fully tighten.
- It is suggested that you check the tightness of the mounting bolts on a regular basis such as when cleaning or once a month.
- R&G will accept no liability if the above procedure and torque settings are not followed.
- Using a Dremel or file, remove material from the front sprocket cover shown in **Picture 2**, until there is a few millimetres of clearance between the case cover and front sprocket cover. (Similar to **Picture 4**)
- Once you have test fitted and are happy with the clearance, fully refit the front sprocket cover, making sure that the overflow lines/wiring is tucked behind the tab on the inside of the front sprocket cover so the wiring/lines do not get caught up in the chain/sprocket.
- Refit the fairing panels and gear linkage.
- Store the 4X OEM engine case bolts.

ISSUE 2 – 14/05/2024 (MH)

CONSUMER NOTICE

The catalogue description and any exhibition of samples are only broad indications of the Products and R&G may make design changes which do not diminish their performance or visual appeal and supplying them in such state shall conform to the order. The Buyer acknowledges no representation or warranty (other than as to title) has been given or will apply to the Products other than those in R&G's order or confirmation and the Buyer confirms it has chosen the Products as being of merchantable quality and suitable for its particular purposes. Where R&G fits the Products or undertakes other services it shall exercise reasonable skill and care and rectify any fault free of charge unless the workmanship has been disturbed. The Buyer is responsible for ensuring that the warranty on the motorcycle is not affected by the fitting of the Products. On return of any defective Products R&G shall at its option either supply a replacement or refund the purchase money but shall not be liable if the Products have been modified or used or maintained otherwise than in accordance with R&G's or manufacturer's instructions and good engineering practice or if the defect arises from accident or neglect. Other than identified above and subject to R&G not limiting its liability for causing death and personal injury, it shall not be liable for indirect or consequential loss and otherwise its liability shall be limited to the amounts paid by the Buyer for the Products or the fitting or service concerned. These terms do not affect the Buyer's statutory rights.

R&G RETURNS POLICY (NON-FAULTY GOODS)

Returns must be pre-authorised (if not pre-authorised the return will be rejected). Goods may only be returned direct to us if they were purchased direct from us (customer must prove if necessary). Otherwise to be returned to original vendor. Goods must be in re-sellable condition, in the opinion of R&G. All returns are subject to a 25% restocking and handling fee (25% of the gross value exc. P&P – at the prevailing price at time of purchase). The customer must pay any and all carriage charges. No returns of



discontinued products, unless within 14 days of purchase. This policy does not affect your statutory rights and does not refer to faulty goods.

FITTING INSTRUCTIONS FOR ECC0398PRO
RHS CLUTCH CASE COVER



THIS KIT CONTAINS THE ITEMS PICTURED AND LABELLED OVER PAGE.
SOME PARTS MAY BE SHOWN FOR CLARITY OF INSTRUCTIONS ONLY.

DO NOT PROCEED UNTIL YOU ARE SURE ALL PARTS ARE PRESENT.

PLEASE READ ALL INSTRUCTIONS BEFORE PROCEEDING.

**IF IN ANY DOUBT WHEN FITTING OUR PRODUCTS, CONSULT ONE OF OUR DEALERS
OR HAVE FITTED BY A QUALIFIED TECHNICIAN.**

**PLEASE BE AWARE THAT THE PLASTIC SKIDDER IS ASSEMBLED IN POSITION FOR PACKAGING
PURPOSES ONLY. YOU WILL NEED TO REMOVE IT, PLACE 1 DROP OF BLUE THREAD LOCK TO
EACH BOLT AND REASSEMBLE ONTO THE ALUMINIUM ENGINE CASE COVER. DO NOT EXCEED
15NM OF TORQUE.**



<u>TOOLS REQUIRED</u>	<u>GENERAL TORQUE SETTINGS</u>
<ul style="list-style-type: none"> • Set of Metric Allen keys. • Metric Socket set. • Suitable Torque Wrench. 	<p>M6 BOLT = 15Nm M8 BOLT = 20Nm M10 BOLT = 40Nm M12 BOLT = 40Nm</p>

LEGEND

ITEM NO.	DESCRIPTION	QTY
ITEM 1	R&G ALUMINIUM ENGINE CASE COVER	1
ITEM 2	SKIDDER ASSEMBLY	1
ITEM 3	M6x40mm CAP HEAD BOLT	4
ITEM 4	12mm OD WASHER	4
ITEM 5	M5x10mm COUNTERSUNK BOLTS	4



ASSEMBLY DIAGRAM

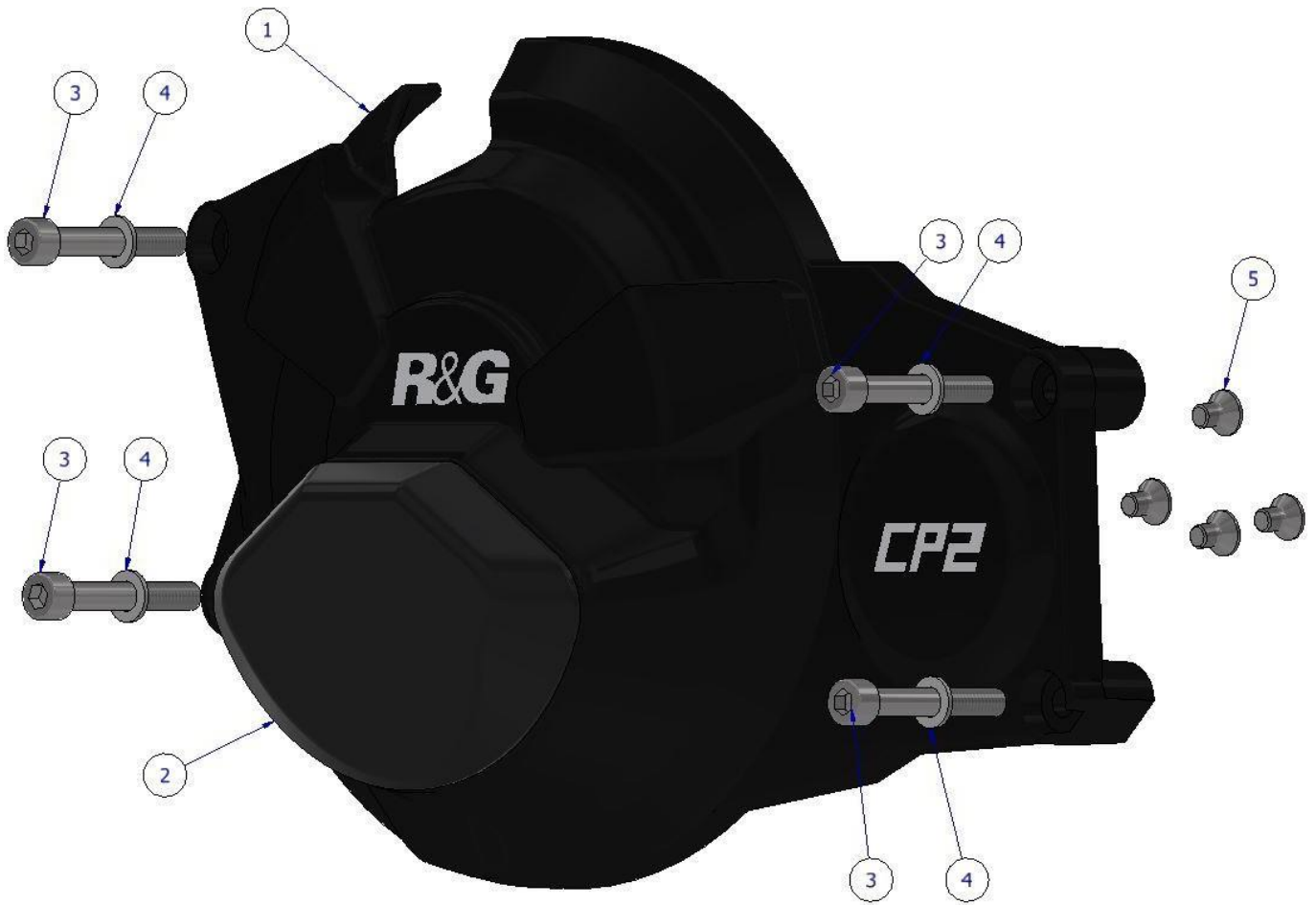

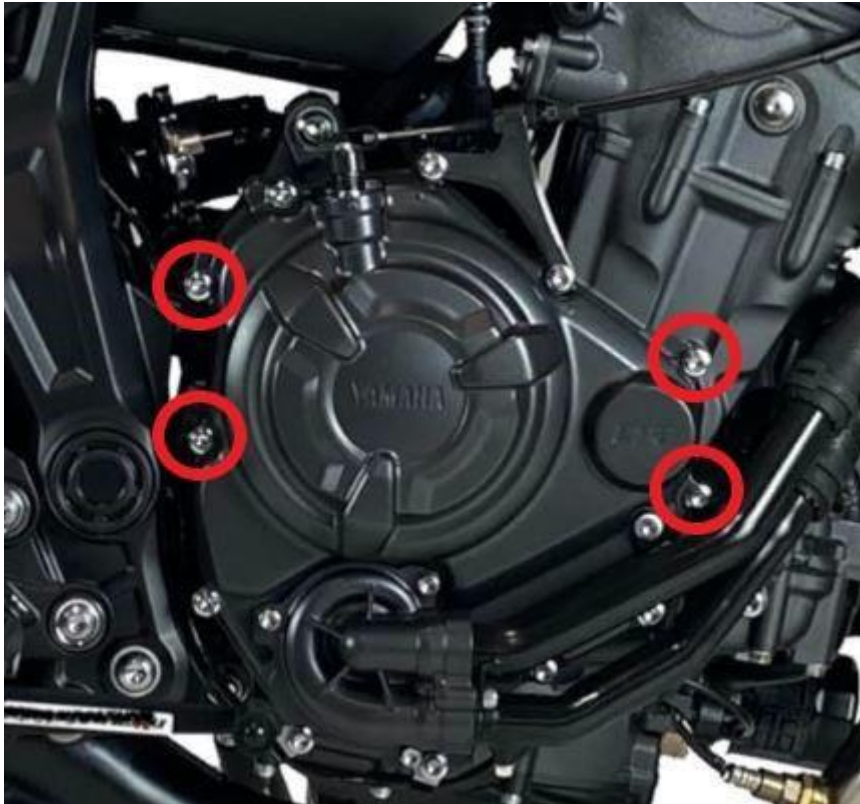

PICTURE 1

FITTING

INSTRUCTIONS

1. Ensure the skidder (**ITEM 2**) is fitted securely to the Engine Case Cover (**ITEM 1**) using the 4 x countersunk bolts (**ITEM 5**).
2. Please make sure the engine is cold before proceeding with the fitting of the R&G cover.
3. Remove the fairings and OEM engine case bolts as highlighted in **PICTURE 1**. **DO NOT REMOVE ALL OF THE CASE BOLTS.**
4. Using the 4 x cap head bolts (**ITEM 3**) and washers (**ITEM 4**) provided to secure the engine case cover to the bike using the **ASSEMBLY DIAGRAM** for reference.
5. With a 5mm hex tool, tighten the bolts equally so that they pull the cover into place. **DO NOT FULLY TIGHTEN.**
6. Finally use a torque wrench set at 10 N/m (7 Lb/ft) to fully tighten.
7. It is suggested that you check the tightness of the mounting bolts on a regular basis such as when cleaning or once a month.
8. R&G will accept no liability if the above procedure and torque settings are not followed.
9. Store the 4X OEM engine case bolts.



ISSUE 2 - 14/05/2024 (MH)

CONSUMER NOTICE

The catalogue description and any exhibition of samples are only broad indications of the Products and R&G may make design changes which do not diminish their performance or visual appeal and supplying them in such state shall conform to the order. The Buyer acknowledges no representation or warranty (other than as to title) has been given or will apply to the Products other than those in R&G's order or confirmation and the Buyer confirms it has chosen the Products as being of merchantable quality and suitable for its particular purposes. Where R&G fits the Products or undertakes other services it shall exercise reasonable skill and care and rectify any fault free of charge unless the workmanship has been disturbed. The Buyer is responsible for ensuring that the warranty on the motorcycle is not affected by the fitting of the Products. On return of any defective Products R&G shall at its option either supply a replacement or refund the purchase money but shall not be liable if the Products have been modified or used or maintained otherwise than in accordance with R&G's or manufacturer's instructions and good engineering practice or if the defect arises from accident or neglect. Other than identified above and subject to R&G not limiting its liability for causing death and personal injury, it shall not be liable for indirect or consequential loss and otherwise its liability shall be limited to the amounts paid by the Buyer for the Products or the fitting or service concerned. These terms do not affect the Buyer's statutory rights.

R&G RETURNS POLICY (NON-FAULTY GOODS)

Returns must be pre-authorized (if not pre-authorized the return will be rejected). Goods may only be returned direct to us if they were purchased direct from us (customer must prove if necessary). Otherwise to be returned to original vendor. Goods must be in re-sellable condition, in the opinion of R&G. All returns are subject to a 25% restocking and handling fee (25% of the gross value exc. P&P – at the prevailing price at time of purchase). The customer must pay any and all carriage charges. No returns of discontinued products, unless within 14 days of purchase. This policy does not affect your statutory rights and does not refer to faulty goods.